



Star
PPS®-Champion

Das wohl schmalste Schraub-Profilssystem
für LVT-Designbeläge und Teppichböden

The possibly narrowest screw profile system
for LVT floors and carpet floor coverings



4 – 9,5 mm (D) (GB)

Unsere bewährte Champion-Technologie

Our proven Champion technology

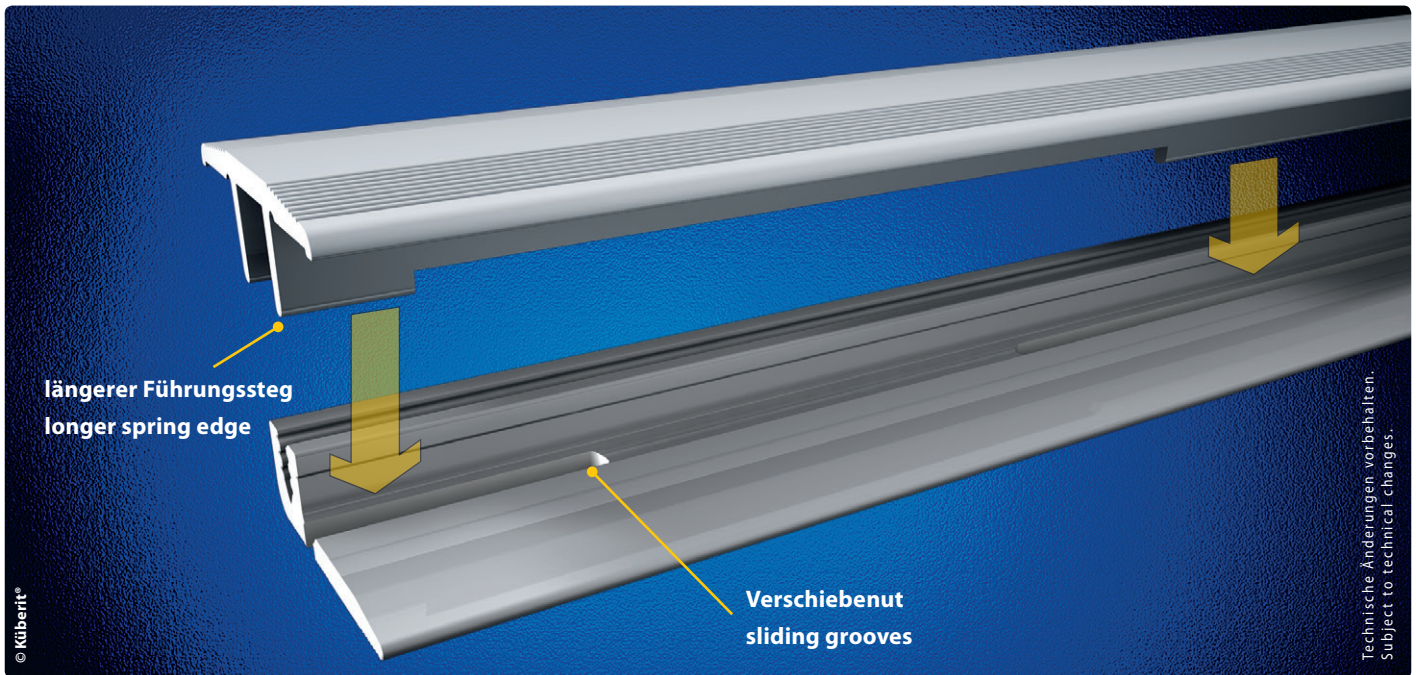

PPS®-Champion Star:

- für Designböden von 4 – 9,5 mm
- für Teppichböden bis zu 12 mm
- wohl schmalstes Schraub-Profilssystem weltweit
- Champion-Technologie mit Verschiebenut
- formschönes TOP-Profil mit geringer Aufbauhöhe
- Einsatz von hochwertigen TORX-Schrauben
- Verstärkung im gesenkten Bohrloch sorgt für eine optimale Befestigung
- das 45 mm breite BASIS-Profil ermöglicht eine seitlich versetzte Bohrung von der Estrichfuge oder eine größere Klebeauftragsfläche

PPS®-Champion Star:

- for LVT floors from 4 – 9.5 mm
- for carpet floors up to 12 mm
- possibly the narrowest screwable profile system worldwide
- Champion-technology with sliding grooves
- appealingly designed TOP profile with a flat buildup
- use of high quality TORX-screws
- reinforced countersunk bore-holes ensure optimum installation
- the 45 mm wide BASE profile allows a laterally offset drilling to the screed joint or a wider adhesive surface



Die einzigartige Verlegelösung

The unique installation solution

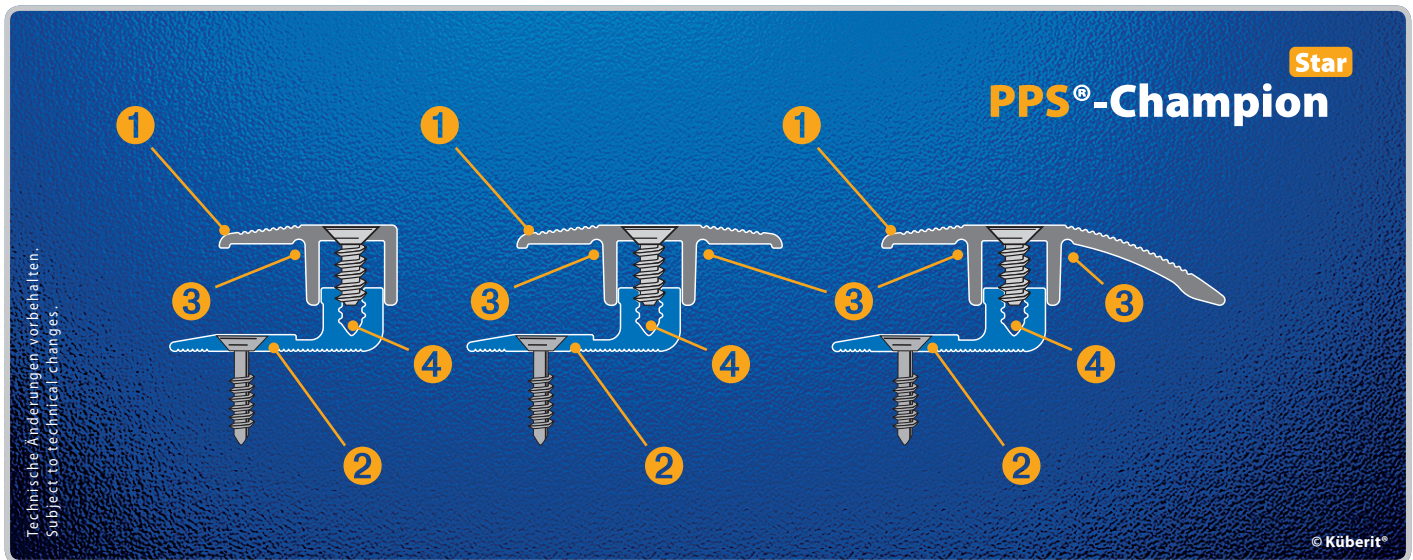

Star PPS®-Champion

PPS®-Champion Star

- ❶ TOP-Profil
- ❷ BASIS-Profil
Befestigung mit TORX-Schraube
(Verdübelung neben der Estrichfuge)
- ❸ Sollbiegestelle
- ❹ Schraubkanal für TORX

PPS®-Champion Star

- ❶ TOP profile
- ❷ BASE profile
fastening with TORX screws
(anchor beside the subfloor joint)
- ❸ predetermined bending point
- ❹ screw channel for TORX

Stufenlos in Höhe und Neigung verstellbar!
Infinitely variable in height and inclination!

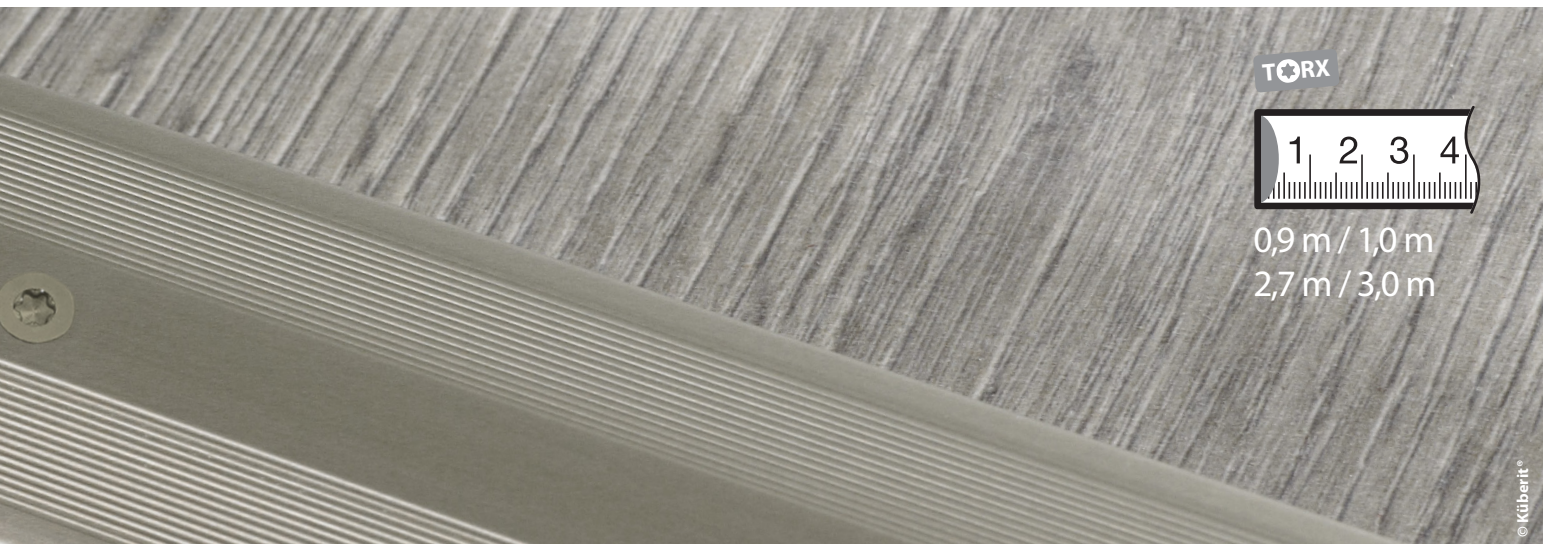
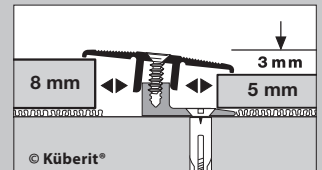
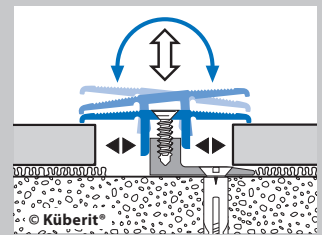

PPS®-Champion Star

PPS®-Champion Star

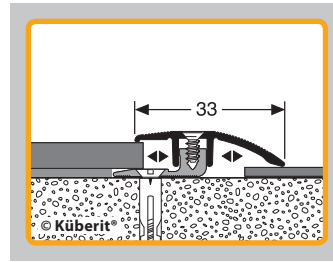
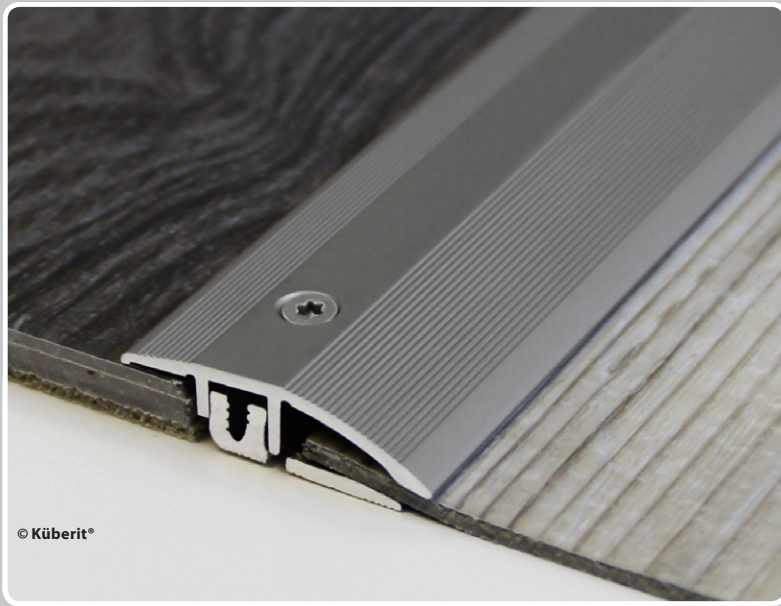

6 mm

376

↕ 4 – 9,5 mm

(5 – 12 mm)*

ANPASSUNGSPROFIL

(oder AUSGLEICHSPROFIL) für alle Bodenbeläge an angrenzende, niedrigere Flächen oder Beläge

ADAPTING PROFILE

(or LEVELLING PROFILE / REDUCER PROFILE) for all floor coverings bordering lower areas or floors

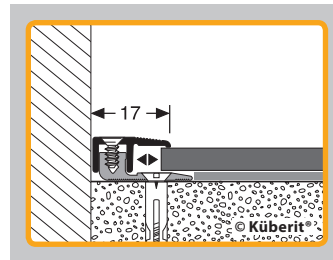
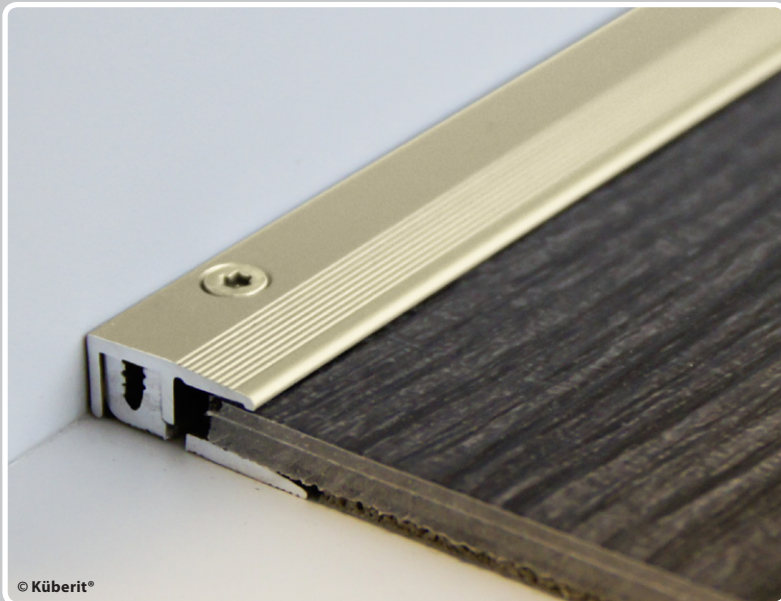

6 mm

377

↕ 4 – 9,5 mm

(5 – 12 mm)*

ABSCHLUSSPROFIL

für saubere Abschlüsse und Begrenzungen von Bodenbelägen vor höheren, angrenzenden Schwellen, Kacheln, Fliesen, Terrassentüren und -fenstern oder anderen Erhöhungen

BORDER PROFILE

for neat borders of floor coverings in front of higher sills, tiles, terrace doors and windows or other raisings

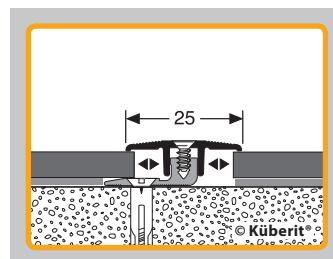

2x 6 mm

378

↕ 4 – 9,5 mm

(5 – 12 mm)*

ÜBERGANGSPROFIL

(oder DEHNUNGSFUGENPROFIL) für gleich hohe oder bis zu ± 3 mm unterschiedlich hohe Bodenbeläge

CONNECTING PROFILE

(or EXPANSION JOINT PROFILE) for floor coverings of equal level or up to ± 3 mm difference in height

* für Teppichböden / for carpet floors

Die optimale Verlegelösung für Designbeläge und Teppiche

The best installation solution for LVT floors and carpets

BASIS-Profil verdübeln und verschrauben
(= Durchsteckmontage) bzw. bei Fußbodenheizung
einen 2-Komponenten-Kleber verwenden.

Screw and anchor the **BASE profile**
(= plug mounting). In case of floor heating,
fasten the profile by using a two components adhesive.

Bodenbelag anpassen, dabei die vom Hersteller
empfohlene **Dehnungsfuge** berücksichtigen!

Lay the floor covering and pay attention
to the **expansion joint** as recommended
by the flooring manufacturer!

Nur bei starken Bodenbelägen unter 5,5 mm
auf die passgenaue Ausrichtung der längeren Schenkel
vom **TOP-Profil** zur Verschiebenut des **BASIS-Profils**
achten und **TOP-Profil** festschrauben.

For floor coverings of less than 5.5 mm thickness,
make sure that the long side of the **TOP profile**
is aligned with the sliding groove of the **BASE profile**
and screw the **TOP profile**.

Höhendifferenzen mit wohldosierten Schlägen zwischen
den Bohrlochern anpassen. (Schlagklotz aus Hartholz und Filz)

Adjust height differences with well controlled hammer blows.
(block of hardwood with felt)

Schrauben nachziehen!

Fertig ist die hochwertige Verlegung!

Afterwards retight all screws again!

Finished is the high quality solution!

VIDEO



kueberit.com/qr/chstar



Mit breitem BASIS-Profil

With wide BASE profile



TORX

Star
PPS®-Champion

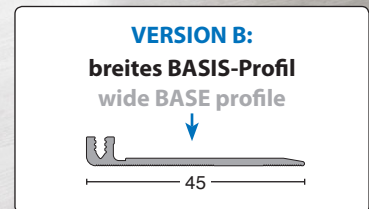

© Kübert®

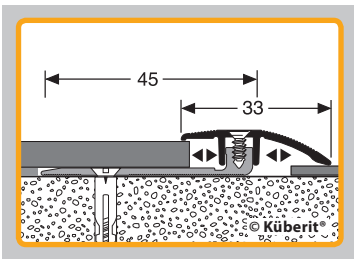

6 mm

376 B
↕ 4–9,5 mm
(5–12 mm)*

ANPASSUNGSPROFIL
ADAPTING PROFILE

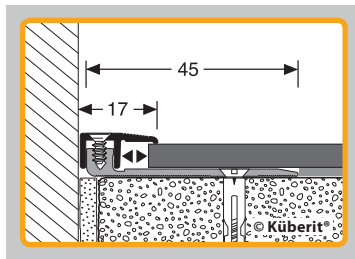

6 mm

377 B
↕ 4–9,5 mm
(5–12 mm)*

ABSCHLUSSPROFIL
BORDER PROFILE

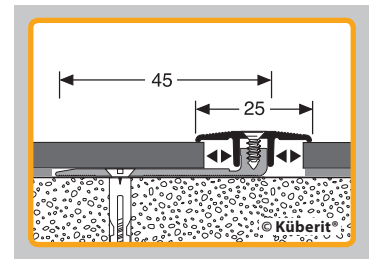

2x 6 mm

378 B
↕ 4–9,5 mm
(5–12 mm)*

ÜBERGANGSPROFIL
CONNECTING PROFILE

* für Teppichböden / for carpet floors

PPS®-LIFTER – zur Basisprofilerrhöhung

PPS®-LIFTER – for lifting the base profile

PPS®-LIFTER

↕ 10 – 20 mm

+ 5 mm

+ 10 mm

aus glasfaserverstärktem Kunststoff (GFK) made of glass-fiber reinforced plastic (GFRP)

© Küberit®

Technische Änderungen vorbehalten.
Subject to technical changes.

SYMBOLE · SYMBOLS

Ce für Keramik
for ceramic

Vi für LVT-Designbeläge und elastische Böden
for LVT floors and elastic floors

Te für Teppichböden
for carpet floors

zum Schrauben
to screw

PPS®-Champion Star – Muster und Verkaufshilfen

PPS®-Champion Star – sample case and sales assistants



Musterkoffer PPS®-Champion Star
sample case PPS®-Champion Star



Mustertafel PPS®-Champion Star
sample board PPS®-Champion Star

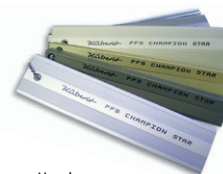

Handmuster
sample swatches

Selbstbedienungsverpackung
retail packaging



FARBEN · COLOURS



F2
Alu eloxiert edelstahloptik
Alu anodized stain, steel optic



F3
Alu poliert
Alu polished



F4
Alu eloxiert silber
Alu anodized silver



F5
Alu eloxiert gold
Alu anodized gold



F6
Alu eloxiert bronze
Alu anodized bronze



F9
Alu eloxiert sand
Alu anodized sand

Technische Änderungen sowie Abweichungen in der Farbe vorbehalten. Subject to technical changes and deviations in colour.



ORIGINAL **Küberit**®
since 1863

Küberit Profile Systems GmbH & Co. KG
Römerweg 9 • 58513 Lüdenscheid • Germany

Tel.: +49 2351 9507 0

Fax: +49 2351 9507 49

Fax Export: +49 2351 9507 200

www.kueberit.com

kueberit@kueberit.com • export@kueberit.com

Ihr Küberit-Fachhändler - Your Küberit dealer - Votre revendeur spécialisé

©Küberit® 04/2018

